

# DLX - DLXB MF/M



[www.etatronds.com](http://www.etatronds.com)

 **ETATRON D.S.**

**IT** NORME DI INSTALLAZIONE, USO E MANUTENZIONE

**UK** OPERATING INSTRUCTIONS AND MAINTENANCE

|   |                |
|---|----------------|
| <b>1.0 - HINTS AND WARNING</b>                                      | <b>PAG. 29</b> |
| 1.1 - WARNING   | 29             |
| 1.2 - SHIPPING AND TRANSPORTING THE PUMP                            | 29             |
| 1.3 - PROPER USE OF THE PUMP  | 29             |
| 1.4 - RISKS   | 29             |
| 1.5 - TOXIC AND/OR DANGEROUS LIQUID DOSAGE                          | 30             |
| 1.6 - ASSEMBLING AND DISMANTLING THE PUMP                           | 30             |
| <b>2.0 - DLX MF/M DLXB MF/M MICROCONTROLLER DOSING PUMPS</b>        | <b>31</b>      |
| 2.1 - OPERATION   | 31             |
| 2.2 - TECHNICAL SPECIFICATIONS                                      | 31             |
| 2.3 - LIQUID ENDS MATERIALS   | 33             |
| <b>3.0 - INSTALLATION</b>   | <b>34</b>      |
| 3.1 - INJECTION VALVE INSTALLATION DIAGRAM                          | 35             |
| <b>4.0 - MAINTENANCE</b>  | <b>36</b>      |
| <b>5.0 - HOW TO OPERATE WHEN DOSING SULPHURIC ACID</b>              | <b>36</b>      |
| <b>6.0 - MULTIFUNCTIONS DOSING PUMP DLX MF/M - DLXB MF/M SERIES</b> | <b>37</b>      |
| 6.1 - PUMP CONTROLS   | 37             |
| 6.2 - TYPICAL INSTALLATION  | 37             |
| 6.3 - ACCESSORIES   | 37             |
| <b>7.0 - WIRING CONNECTION AND OUTPUT CONNECTOR FUNCTIONS</b>       | <b>38</b>      |
| <b>8.0 - DESCRIPTION OF OPERATING MODE</b>                          | <b>39</b>      |
| 8.1 - DESCRIPTION OF ADDITIONAL FEATURES                            | 40             |
| 8.2 - INPUT/OUTPUT EXTERNAL CONNECTIONS (FOR EXTERNAL ACCESSORY)    | 40             |
| <b>9.0 - TROUBLE SHOOTING COMMON TO DLX - DLXB MF SERIES</b>        | <b>42</b>      |
| 9.1 - MECHANICAL FAULTS   | 42             |
| 9.2 - ELECTRICAL FAULTS   | 42             |
| 9.3 - RESTORATION OF DEFAULT PARAMETERS                             | 43             |
| <b>10.0 - FLOW DIAGRAMS (DISPLAY)</b>                               | <b>44-54</b>   |
| <b>EXPLODED VIEWS</b>   | <b>55-57</b>   |

## 1.0 - HINTS AND WARNINGS

Please read the warning notices given in this section very carefully, because they provide important information regarding safety in installation, use and maintenance of the pump.

- Keep this manual in a safe place, so that it will always be available for further consultation.
- The pump complies with EEC directives No.89/336 regarding "electromagnetic compatibility" and No.73/23 regarding "low voltages", as also the subsequent modification No.93/68.

**N.B. The pump has been constructed in accordance with best practice. Both its life and its electrical and mechanical reliability will be enhanced if it is correctly used and subjected to regular maintenance.**

### 1.1 - WARNING:

**Any intervention or repair to the internal parts of the pump must be carried out by qualified and authorized personnel. The manufacturers decline all responsibility for the consequences of failure to respect this rule.**

**GUARANTEE: 1 year (the normal wearing parts are excluded, i.e.: valves, nipples, tube nuts, tubing, filter and injection valve). Improper use of the equipment invalidates the above guarantee. The guarantee is ex-factory or authorized distributors.**

### 1.2 - SHIPPING AND TRANSPORTING THE PUMP

The pump should always be moved in a vertical (and never in a horizontal) position. No matter what the means of transport employed, delivery of the pump, even when free to the purchaser's or the addressee's domicile, is always at the purchaser's risk. Claims for any missing materials must be made within 10 (ten) days of arrival, while claims for defective materials will be considered up to the 30th (thirtieth) day following receipt. Return of pumps or other materials to us or the authorized distributor must be agreed beforehand with the responsible personnel.

### 1.3 - PROPER USE OF THE PUMP

- The pump should be used only for the purpose for which it has been expressly designed, namely the dosing of liquid additives. Any different use is to be considered improper and therefore dangerous. The pump should not therefore be used for applications that were not allowed for in its design. In case of doubt, please contact our offices for further information about the characteristics of the pump and its proper use.
- The manufacturers cannot be held responsible for damage deriving from improper, erroneous or unreasonable use of the pump.

### 1.4 - RISKS

- After unpacking the pump, make sure it is completely sound. In case of doubt, do not use the pump and contact qualified personnel. The packing materials (especially bags made of plastics, polystyrene, etc.) should be kept out of the reach of children: they constitute potential sources of danger.
- Before you connect the pump, make sure that the voltage ratings, etc., correspond to your particular power supply. You will find these values on the rating plate attached to the pump.
- The electrical installation to which the pump is connected must comply with the standards and good practice rule in force in the country under consideration.
- Use of electrical equipment always implies observance of some basic rules: In particular:
  - 1 - do not touch the equipment with wet or damp hands or feet;
  - 2 - do not operate the pump with bare feet (Example: swimming pool equipment);
  - 3 - do not leave the equipment exposed to the action of the atmospheric agents;
  - 4 - do not allow the pump to be used by children or unskilled individuals without supervision;
- In case of breakdown or improper functioning of the pump, switch off, but do not touch. Contact our technical assistance for any necessary repairs and insist on the use of original spares. Failure to respect this condition could render the pump unsafe for use.
- When you decide to make no further use of an installed pump, make sure to disconnect it from the power supply.

**Before carrying out any service on the item, check:**

1. **Disconnect the pins from the mains or by means of a two poles switch with 3 mm minimum distance between the contacts. (Fig. 4).**
2. **Relieve all the pressure from the pump head and injection tube.**
3. **Drain or flush all dosing liquid from the pump head. This operation can also be done with the pump disconnected from the plant by turning the pump upside-down for 15 to 30 seconds and without connecting the tubing to the nipples: if this operation is not possible, dismount and remount the pump head using the four mounting screws.**

**In event of possible losses in the hydraulic system of the pump (breakage of the "O" ring gasket, the valves or the hoses) the pump should immediately be brought to a stop, emptying and depressurizing the delivery hose while taking all due safety precautions (gloves, goggles, overalls, etc.).**

### 1.5 - TOXIC AND/OR DANGEROUS LIQUID DOSAGE

To avoid risk from contact with the hazardous liquids or toxic fumes, always adhere to the notes in this instruction manual:

- Follow the instructions of the dosing liquid manufacturer.
- Check the hydraulic part of the pump and use it only if it is in perfect condition.
- Use only the correct materials for the tubing, valves and seals to suit the liquid to be dosed; where possible shield the tubing with PVC conduit.
- Before disconnecting the metering pump, make sure to flush out and neutralize the pump head with the proper reagent liquid.

### 1.6 - ASSEMBLING AND DISMANTLING THE PUMP

#### 1.6.1 - ASSEMBLY

All metering pumps are normally supplied fully assembled. For greater clarity, please consult the exploded view of the pump appended at the end of the manual, which shows all the pump details and a complete overview of all the pump components. These drawings are in any case quite indispensable whenever defective parts have to be re-ordered. For the same purpose, the appendix also contains other drawings showing the hydraulic parts (pump head and valves).

#### 1.6.2 - DISMANTLEMENT

Proceed as follows before you dismantle the pump or before performing any other operation on it:

1. Disconnect the pins from the mains or by means of a two poles switch with 3 mm minimum distance between the contacts. (Fig. 4).
2. Relieve all the pressure from the pump head and injection tube.
3. Drain or flush all dosing liquid from the pump head. This operation can also be done with the pump disconnected from the plant by turning the pump upside-down for 15 to 30 seconds and without connecting the tubing to the nipples: if this operation is not possible, dismount and remount the pump head using the four mounting screws. (Fig. 10).

This operation calls for special attention, and you should therefore consult the drawings in Appendix and Chapter 1.4 "RISKS" before you commence work.

### **(UK) WASTE OF ELECTRICAL AND ELECTRONIC EQUIPMENT DIRECTIVE (WEEE, RAEE in Italy) 2002/96/EC AND SUBSEQUENT AMENDMENT 2003/108/EC**

The marking shown below indicates that the product cannot be disposed of as part of normal household waste. Electrical and Electronic Equipment (EEE) can contain materials harmful to health and the environment, and therefore is subject to separate waste collection: it must be disposed of at appropriate waste collection points or returned to the distributor against purchase of new equipment of similar type or having the same functions. The directive mentioned above, to which make reference for further details, provides for punitive actions in case of illegal disposal of such waste.



## OVERALL DIMENSIONS (Fig. 1)

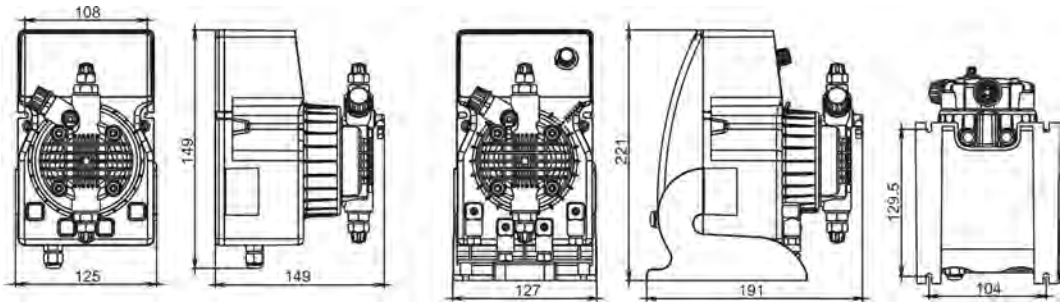

**DLX**

**DLXB**

### 2.0 - DLX-MF/M AND DLXB-MF/M MICROCONTROLLER DOSING PUMPS

Multifunction dosing pumps with a microprocessor and a liquid crystal display allow an accurate injection pulse choice.

#### 2.1 - OPERATION

The metering pump is activated by a teflon diaphragm mounted on a piston of an electromagnet. When the piston of the electromagnet is attracted, a pressure is produced in the pump body with an expulsion of liquid from the discharge valve. Once the electric impulse is finished a spring brings the piston back to the initial position, with a recall of liquid through the suction valve. The operation is simple the pump does not need lubrication, therefore maintenance is reduced almost to zero. The materials used for the construction of the pump make it particularly suitable for aggressive liquids. The metering pump has been designed to feed liquids with capacities from 0 to 20 l/h and pressures from 0 to 15 bar (depending on the model selected).

#### 2.2 - TECHNICAL SPECIFICATIONS

- The products are manufactured according to CE regulation.
- Environmental Conditions: IP 65 protection, altitude up to 2000m, ambient temperature 5C to 40C, maximum relative humidity 80% for temperatures up to 31°C decreasing linearly to 50% relative humidity at 40°C.
- Pollution degree 2
- Overvoltage cat. II
- Antiacid plastic casing.
- Control panel protection assured by an adhesive polyester film, weatherproof and resisting UV ray
- Standard power supply (the fluctuations not to exceed ±10%):  
230 Vac 50-60 Hz single phase.
- Optional power supply (the fluctuations not to exceed ±10%):  
240 Vac 50-60 Hz single phase;  
110 Vac 50-60 Hz single phase.
- We are preparing the following:  
24Vac - 24Vdc - 12Vdc

Upon request: manual stroke length adjustment. This control provides accurate flow adjustment. (only DLXB series)

#### OPERATING FUNCTIONS:

##### Manual

The pump can be programmed to operate in one of the following ways:

- Operating range: 0 – 120 pulses per minute  
0 – 120 pulses per hour  
0 – 48 pulses per day

##### 1xN

When a pulse generating water meter is connected to the pump, every pulse received will cause the pump to pulse N times. Operating range: 0 – 999 pulses for each contact  
0 – 120 pulses per minute

##### 1xN(M)

Every pulse from a water meter will cause the pump to pulse N times. While the pump is pulsing, it still registers all further signals received (M) and translates them into successive pulses. Operating range: 0 – 999 pump pulses (value of N) for each signal received

- 1 : N** Every N number of signals received on the connector, the pump supplies an injection 0-999 pulses for each contact
- mA** The pump doses in proportional way to the power signal  
 Operating range: 0 – 20 mA pulses per minute  
 0-120 pump pulses per minute  
 Minimum and maximum cutoff points are adjustable: **Stop/Continue** dosing
- PPM** The pump can dose directly in PPM. User can set the following parameters:  
 Water meter liter/contacts 0.1, 0.25, 0.5, 1, 2.5, 5, 10, 25, 50, 100, 250, 500, 1000. cc/injection 0.00 - 20.00 Concentration of solution (%) - PPM 0.1 – 20.000

**ACCESSORY FUNCTIONS:**

**FLOW ALARM** The pump controls by mean of a device called flow sensor if the injection are really done and will warn the user in case of the selected conditions are not achieved. The user will see a yellow led light-on and the intervention of the service relay and the sound of the buzzer.  
 Reference injections 0-100; Max injection difference 0-100.

**LOSS OF POWER** In case of loss of power for a period not above 24 hours, in which the internal battery will remane charged, the internal circuit will show such condition with a yellow led light and the intervention of the of the service relay.

**ALARM FOR TOO MANY INCOMING PULSES** During functions 1xN(M) and PPM the pump controls the number of injection that must be done. In case that, the number of injections are higher then 4xN (N are the number of pulses to be done for every incoming signal) the pump will generate an alarm wich will light on the yellow led and operates the service relay.

**OUTPUT SERVICE RELAY** This relay will be closed when a loss of power and/or an excessive amount of pulses will be present or flow alarm will arrive.  
 Characteristic: 1 pole - 250V a.c. 5A (resistive load)

**BUZZER** Audible alarm for missed pump pulses can be **Enabled / Disabled**

**CLOCK** Date and time  
 day/month/year  
 hour/minutes  
 Clock holds its settings in the case of power failure of up to 2 hours. Prior to initial use, pump should be powered for 12 Hrs to precharge internal battery

**REMOTE CONTROL** Ability to control the pump (START / STOP) from normal or reversed polarity remote location

**TIMER** Built-in weekly and daily timer  
 8 cycles of daily on/off operation. Setting to the minute

**LANGUAGE** Menu languages choice: Italian / English

**Serial line RS232** This connector (Pos. 4 - see chapter 7.0) is used only to update the software, although it has an input to totally reset the pump only if it goes to permanent block.

- Pulses characteristic**
- Pulse duration mSec.:80 (user can not change it)
  - Max pulses frequency / minute: 120
  - Max pulses frequency / hour: 120
  - Max pulses frequency / day: 48

- Input connectors characteristic**
- Min contact duration mSec.:10
  - Max contact number / second:40

- “mA” characteristic / function**
- Ampere meter accuracy: 0,1 mA
  - Setting mA (1) SET 1: 4,0 mA

- Setting mA (2) SET 2: 20,0 mA
- Pulses/minute (1) SET 1: 0
- Pulses/minute (2) SET 2: 100÷120
- Below mA (1) SET 1: Stop
- Above mA (2) SET 2: Stop

**Remote control:** Closing /opening delay contact: 3 seconds - Polarity: Normal

### 2.3 - LIQUID ENDS MATERIALS

- **DIAPHRAGM:** PTFE
- **PUMP HEAD:** Polypropylene; upon request: PVC, 316 Stainless Steel, PTFE, PVDF.
- **NIPPLES:** polypropylene
- **FILTER:** polypropylene
- **INJECTION NIPPLE:** polypropylene
- **SUCTION HOSE:** PVC - flexible
- **DISCHARGE HOSE:** polyethylene
- **VALVES:** "lip" type FPM (Viton®) upon request available in EPDM (Dutral®), NBR, Silycon.
- **"Ball Check" VALVES** upon request type in SS 316 and Glass PYREX. Available with Spring Return and "KALREZ" Valve.
- **SEALS:** FPM (Viton®) upon request EPDM (Dutral®), NBR, Silycon, PTFE only for ball checks valves

### MAIN FEATURES

| Tipo Type | Portata max Max flow l/h | Pressione max Max press bar | Max imp./min. Max imp./min. | Dosaggio per imp. Output per stroke ml | Corsa Stroke mm | Altez. aspiraz. Suction height m | Aliment. elettr. standard Standard power supply Volts - Hz | Potenza ass. Power comp. Watts | Corrente ass. Current comp. Ampere | Peso netto Net weight kg |
|-----------|--------------------------|-----------------------------|-----------------------------|--|-----------------|----------------------------------|--|--------------------------------|------------------------------------|--------------------------|
| 1-15      | 1                        | 15                          | 120                         | 0.14                                   | 0.80            | 2.0                              | 230 V 50-60 Hz   | 37                             | 0.16                               | 2.3                      |
| 2-10      | 2                        | 10                          | 120                         | 0.28                                   | 0.80            | 2.0                              | 230 V 50-60 Hz   | 37                             | 0.16                               | 2.3                      |
| 5-7       | 5                        | 7                           | 120                         | 0.69                                   | 1.00            | 2.0                              | 230 V 50-60 Hz   | 37                             | 0.16                               | 2.3                      |
| 5-12      | 5                        | 12                          | 120                         | 0.69                                   | 1.00            | 2.0                              | 230 V 50-60 Hz   | 58                             | 0.25                               | 2.9                      |
| 8-10      | 8                        | 10                          | 120                         | 1.11                                   | 1.40            | 2.0                              | 230 V 50-60 Hz   | 58                             | 0.25                               | 2.9                      |
| 15-4      | 15                       | 4                           | 120                         | 2.08                                   | 2.20            | 2.0                              | 230 V 50-60 Hz   | 58                             | 0.25                               | 2.9                      |
| 20-3      | 20                       | 3                           | 120                         | 2.60                                   | 2.20            | 2.0                              | 230 V 50-60 Hz   | 58                             | 0.25                               | 2.9                      |
| 2-20      | 2                        | 20                          | 120                         | 0.28                                   | 1.00            | 2.0                              | 230 V 50-60 Hz   | 58                             | 0.25                               | 2.9                      |

Fig. 2

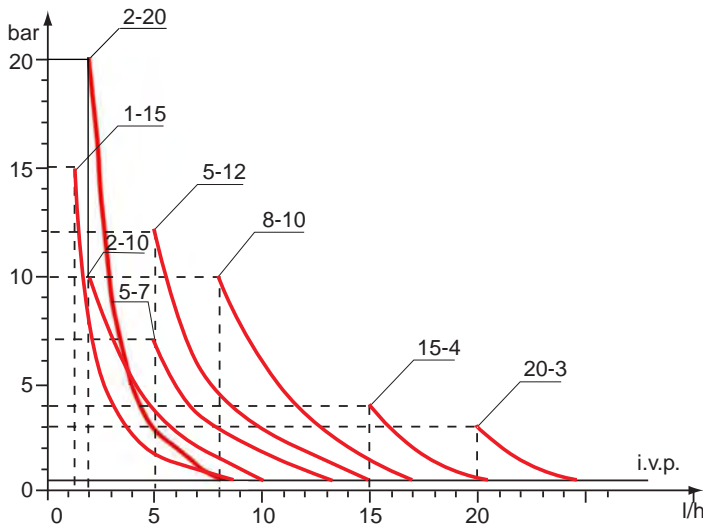

Fig. 3

The diagrams of fig. 3 indicate max metering pump flow variation in relation to the working pressure in the plant; the diagrams also include injection valve losses. I.V.P. Due to production requirements the technical characteristics of our equipment at maximum ratings can vary with a tolerance of 5% which must be taken into account when choosing the type of pump.

### 3.0 - INSTALLATION

- a. - Install the pump in a dry place and well away from sources of heat and, in any case, at environmental temperatures not exceeding 40°C. The minimum operating temperature depends on the liquid to be pumped, bearing in mind that it must always remain in a liquid state.
- b. - Carefully observe the regulations in force in the various countries as regards electrical installations (Fig.4). **When the supply cable is devoid of a plug, the equipment should be connected to the supply mains by means of a two-poles switch having a minimum distance of 3 mm between the contacts. Before accessing any of the electrical parts, make sure that all the supply circuits are open.**

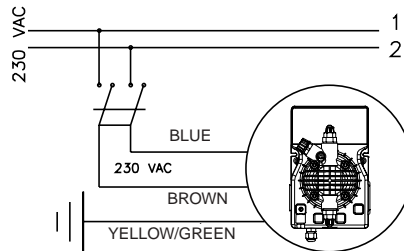

Fig. 4

- c.- Locate the pump as shown in fig. 5 bearing in mind that it may be installed either below or above the level of the liquid to be dosed, though the level difference should not exceed 2 meters. When the process plant in which the pump is installed is operating at atmospheric pressure (no back pressure) and the chemical tank is situated above the plant (Fig. 6), the condition of the injection valve should be checked at regular intervals, because excessive wear and tear could cause additive to drip into the plant even when the pump is shut down. If the problem persist, install a properly calibrate **counter-pressure valve (C)** between injection point and the valve. In the case of liquids that generate aggressive vapours, do not install the pump above the storage tank unless the latter is hermetically sealed.

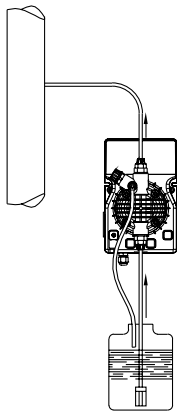

Fig. 5

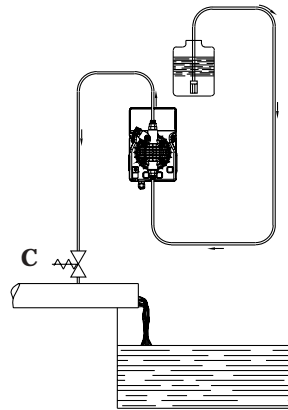

Fig. 6

- d. - The discharge nipple will always remain in the upper part of the pump. The suction nipple, which serves to attach the hose (with filter) leading into the chemical tank, will therefore always be situated in the lower part of the pump.

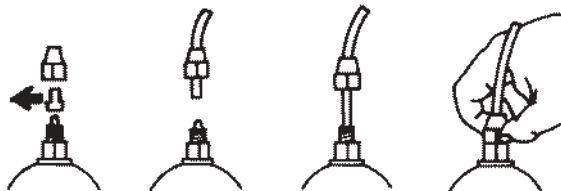

Fig. 7

- e. - Remove the protection caps from the two nipples, slide the hoses over the connectors, pushing them right home, and then fix them with appropriate tube nuts. (Fig. 7).



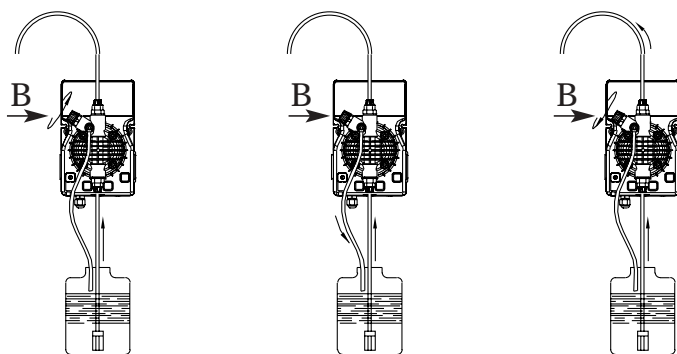

Fig. 8

Whenever the pump is dismantled from the pipework, you will be well advised to replace the caps on the connectors to avoid residual liquid being spilled. Before attaching the delivery hose to the plant, prime the metering pump by going through the sequence shown in Fig. 8. Before finalizing the installation of the discharge hose, make sure that the pump strokes will not cause it to move and bump into rigid bodies. In case of priming difficulties, use a normal syringe to suck liquid from the discharge nipple while the pump is in operation, continuing until you actually see the liquid rise in the syringe. Use a short length of suction hose to connect the syringe to the discharge nipple. In case of a pump equipped with an air bleed valve, unscrew the air relief valve B up to all the air in the pump head will be out.

- f. - Try to keep both the suction and discharge hose as straight as possible, avoiding all unnecessary bends.
- g. - Select the most appropriate injection point on a pipe of the plant to be treated and there fit a 3/8" female gas thread connector (similar to BSPm). This connector is not supplied with the pump. Screw the injection valve to the gas connector, inserting a gasket as shown in Fig. 9. Then connect the discharge hose to the conical connector on the injection valve and fix it with the supplied tube nut G. The injection valve also acts as no return valve by means of a cylinder sleeve (elastomer, standard supplied in Viton).

**N.B. The sleeve D must not be removed.**

### 3.1 - INJECTION VALVE INSTALLATION DIAGRAM Fig. 9

- A - Pipework
- C - Injection valve
- M - Conical connector for attaching the discharge hose
- N - 3/8" female steel gas thread connector
- G - Hose tube nut
- T - Polyethylene hose
- D - Cylinder sleeve (no return valve)

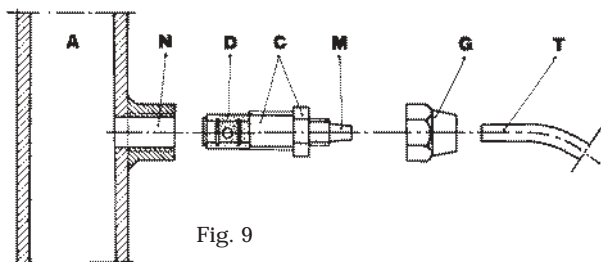

Fig. 9

### 3.2 - MANUAL STROKE LENGTH ADJUSTMENT - (upon request only for DLXB)

- press and turn the knob (1) up to the stroke length adjustment required.



## 4.0 - MAINTENANCE

1. Periodically check the chemical tank level to avoid the pump operating without liquid. This would not damage the pump, but may damage the process plant due to lack of chemicals.
2. Check the pump operating condition at least every 6 months, pump head position, screws, bolts and seals; check more frequently where aggressive chemicals are pumped, especially:
  - pulse and power L.E.D.;
  - the additive concentration in the pipework; a reduction of this concentration could be caused by the wearing of the valves, in which case they need to be replaced (Fig. 10) or by the clogging of the filter which then has to be cleaned as in point 3 here below.

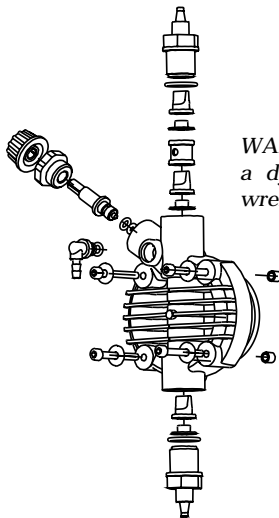

WARNING: to tightening the four screws, use a dynamometric screw driver, set the torque wrench to 1,8N x m.

Fig. 10

3. The Company suggests periodically cleaning off the hydraulic parts (valves and filter). We cannot say how often this cleaning should be done as it depends on the type of application, we also cannot suggest what cleaning agent to use as this will depend on the additive used.

Operating suggestions when dosing sodium hypochlorite (most frequent case):

- a - disconnect the pins from the mains or by means of a onnipolar switch with 3 mm minimum distance between the contact.
- b - disconnect discharge hose from pipework;
- c - remove the suction hose (with filter) from the tank and dip it into clean water;
- d - switch on the metering pump and let it operate with water for 5 to 10 minutes;
- e - switch OFF the pump, dip the filter into a hydrochloric acid solution and wait until the acid finishes cleaning;
- f - switch ON the pump again and operate it with hydrochloric acid for 5 minutes in a closed-circuit, with suction and discharge hose dipped into the same tank;
- g - repeat the operation with water;
- h - re-connect the metering pump to the pipework.

## 5.0 - HOW TO OPERATE WHEN DOSING SULPHURIC ACID (50% MAX FOR STD PUMP)

In this case it is essential to bear in mind the following:

1. replace PVC crystal suction hose with polyethylene discharge hose;
2. empty any residual water from the pump head beforehand.

**Warning: if the water mixes with sulphuric acid it can produce a large quantity of gas with consequent overheating of the area causing damage to valves and pump head.**

This operation can also be done with the pump disconnected from the plant by turning the pump upside-down for 15 to 30 seconds and without connecting the hose to the nipples; if impossible, dismount and remount the pump head (Fig. 10) using the four mounting screws.

# DLX-MF/M • DLXB-MF/M

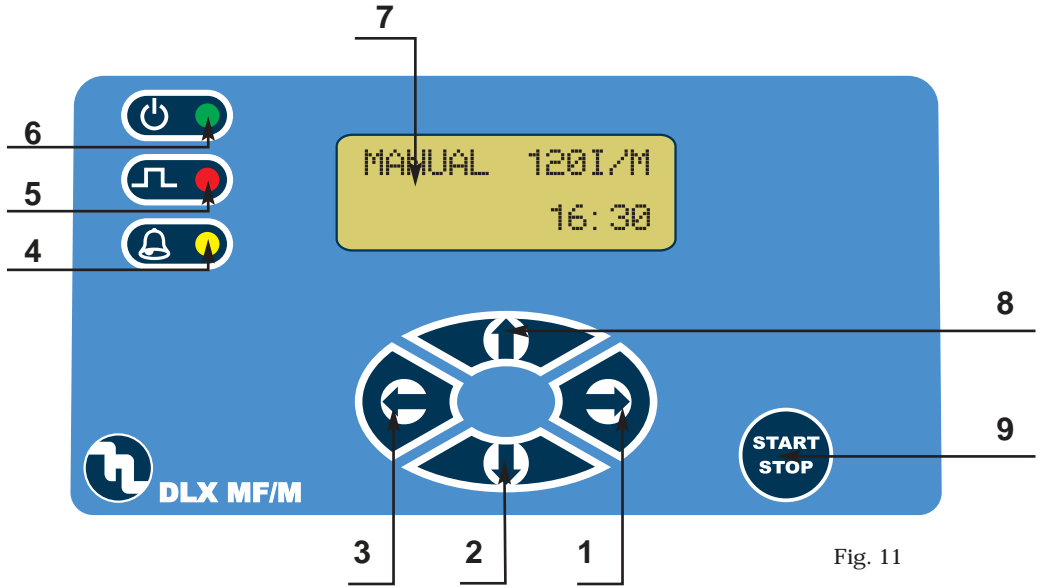

Fig. 11

## 6.0 - MULTIFUNCTIONS DOSING PUMP DLX MF/M; DLXB MF/M SERIES

Multifunctions dosing pump with a microcontroller and a LCD (liquid cristal display) allows an accurate injection pulses choice.

### 6.1 - PUMP CONTROLS (Fig. 11)

- 1 - Increasing values button - movement in the programming menu
- 2 - "Next program" button
- 3 - Decreasing values button - movement in the programming menu
- 4 - "Yellow" LED flow sensor alarm/max allowed pulse difference
- 5 - "Red" LED injection pulse flashing
- 6 - "green/red" LED pump fed/stand by
- 7 - LCD display
- 8 - "Previous program" button
- 9 - Activation/Deactivation metering button

### 6.2 - TYPICAL INSTALLATION (Fig.12)

- A Injection valve
- B Power supply
- C Filter
- D Floating level switch
- F Water meter connector - mA input
- G Level switch connector - flow alarm
- K Water meter
- I Chemical tank
- M Relay output connector
- O RS232 - Reset connector
- Q Flow alarm
- V Process tank

### 6.3 - ACCESSORIES

- 1 flexible PVC suction hose, transparent crystal type, length 2 m;
- 1 semirigid polyethylene hose, white, length 2 m;
- 1 injection valve 3/8 BSP m;
- 1 filter;
- 1 instructions/operating booklet.

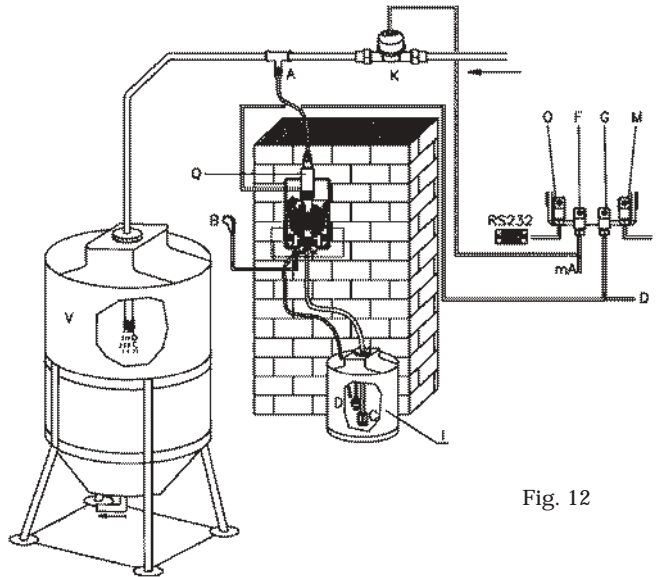
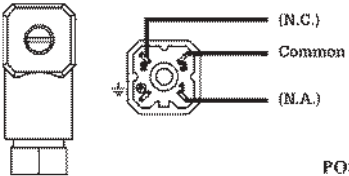
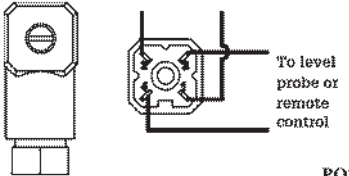
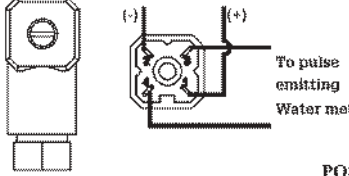
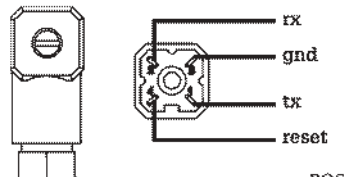

Fig. 12

## 7.0 - WIRING CONNECTION AND OUTPUT CONNECTOR FUNCTIONS



| Female service connector wire assembly  | Functions and technical informations  |
|---|---|
|    | <p><b>Relay service output connection</b><br/>(valid only power is on)<br/>Configuration:<br/>Pin 1 = Normally open<br/>" 2 = Normally closed<br/>" 3 = Common<br/>" 4 = Not connected</p>  |
|   | <p><b>Level probe connection - remote control;</b><br/><b>Flow sensor</b><br/>Configuration :<br/>Pin 1 = Flow sensor<br/>" 2 = Flow sensor<br/>" 3 = Level probe wire (remote control)<br/>" 4 = Level probe wire (remote control)</p> |
|  | <p><b>Pulse emitting water meter connection - mA input</b><br/>Configuration :<br/>Pin 1 = (+) mA signal<br/>" 2 = (-) mA signal<br/>" 3 = Water meter signal wire<br/>" 4 = Water meter signal wire</p>                                |
|  | <p><b>RS 232 - Reset connection</b><br/>Configuration :<br/>Pin 1 = tx - transmit<br/>" 2 = rx - receive<br/>" 3 = gnd - ground<br/>" 4 = Reset</p>   |

The external connector pos. 4 is used only to update the software but it has input to totally reset the equipment. This is infact protected by external problems of such entity which could compromise its proper working. Only in such situation the pump could go in protection (permanent block) but it is possible to reset its working by linking for a while, connector Pins 3 and 4. Any damage can be stand by the microcontroller as it is protected by (over writing) accidental caused by such problems.

## 8.0 DESCRIPTION OF OPERATING MODE

### MANUAL

In this mode, the pump operates with its flow rate manually controlled the keypad. Stroke rate can be set in three ways:

- Pulses per minute (this is common for normal metering pump operations).
- Pulses per hour.
- Pulses per day.

Note: if external flow sensor (optional) is not installed "Reference Injections" and "Max. Injection Difference" must be set to zero.

### 1 x N

When a water meter generating a reed switch signal is connected to the pump, every pulse received from the water meter causes the pump to pulse N times. With the keypad, the user sets the following parameters:

- The value of N, the number of pump pulses for each water meter pulse received.
- Pump stroke rate, how fast the N pulses will occur.

While the pump is still pulsing, further water meter pulses received are ignored.

Example:

- Pump in "1 x n" mode.
- N set to "23".
- The moment the water meter or other device emits a pulse, the pump starts dispensing 23 injections. If the contact is closed again during this phase, these are ignored.
- On completion of the 23 injections, the pump waits for the next pulse to restart the dispensing cycle.

### 1 X N(M)

This position is different from the previous one for the following reason: while the pump is working to generate injections, if one or more pulses are received during the discharging phase, these are recorded and the pump effects the number of injections obtained by multiplying the contacts received by N on completion of first batch.

Example:

- Pump in "1 x n (M)" mode.
  - N set to "23".
  - The moment the water meter emits a pulse, the pump will effect 23 injections. If the contact closes again during this phase, e.g. 5 times, the microprocessor multiplies the two data and the pump supplies 115 injections (23 x 5).
  - On completion of the 115 injections, the pump waits for the next external pulse to restart the dispensing cycle.
- To be noted that if the incoming signal stored in the memory will cause the situation that the pump have to generate injections higher then 4xN. The pump will generate an alarm wich will activate the service relay, light on the yellow led, sounds the buzzer and stops the pump operation.

### 1/N

In this mode, N number of water meter pulses received will activate the pump to pulse once. The value of N is set by the user.

Example:

- Pump in "1 / n" mode.
- N set to "23".
- The moment the water meter or other device has emitted 23 pulses, the pump gives an injection.

### mA

In this mode, the pump accepts an incoming 0-20 mA signal to control its stroke rate. This allows for remote and proportional control. From the pump control panel, the user sets the following:

- 1 - "Set 1", the value in mA which the pump should start pumping, eg. 0.0 mA, 4.0 mA, etc.
- 2 - "Set 2", the value in mA which the pump should stop pumping, eg. 18.0 mA, 20.0 mA, etc.
- 3 - The pump stroke rate at "Set 1", eg. 4.0 mA = 0 strokes/minute, etc.
- 4 - The pump stroke rate at "Set 2", eg. 20.0 mA = 120 or 160 strokes/minute, etc.
- 5 - Whether the pump should continue working or stop if the incoming signal falls below "Set 1".
- 6 - Whether the pump should continue working or stop if the incoming signal rises above "Set 2".

In this mode, pump stroke rate (and thus stroke rate) is proportional for all mA values between "Set 1" and "Set 2". Since Set 1 and Set 2 can be independently set, reverse signal input operation (e.g. 20-4 mA) is also possible. For example:

- Set 1 = 20 mA at 0% of pump flow rate.
- Set 2 = 4 mA at 100% of pump flow rate.

### PPM

The PPM (parts per million) mode allows for very accurate chemical dosage. The pump must be connected to a contact water meter for this function to work. The user uses the pump keypad to program the following:

- Input of contact water meter details in litres per pulse: 0.1, 0.25, 0.5, 1, 2.5, 5, 10, 25, 50, 100, 250, 500 or 1,000 litres per pulse.
- The volume per pump pulse, from 0.01 to 20.00 cc. Our pumps have cc/pulse ratings, but for greater accuracy due difference in liquid properties, the user would need to calibrate the volume of each pump pulse at site, using a measuring cylinder.
- Concentration of the chemical solution being pumped (% solution), eg. 5% Sodium Hydroxide, 98% Sulphuric Acid, etc.
- PPM desired, from 0.1 to 20,000 p.p.m.  
Using the information above, the microprocessor in the pump will calculate accurately the number of pump pulses per volume of water which passes through the water meter.

## **8.1 DESCRIPTION OF ADDITIONAL FEATURES**

### **FLOW ALARM WITH FLOW SENSOR (OPTIONAL)**

Should the pump fail to pulse for any reason, an alarm buzzer sounds to warn the user. The pump then stops by itself and a yellow warning LED comes on, signaling that it needs the user's attention. The relay output (connector no. 1) is activated. The tolerance limit for the activation of this alarm to be activated can be set by the user (the number of missed pulses before the alarm comes on).

**Reference pulses:** periodic break between a control and the following one.

**Max count diff.:** maximum pulses to which does not correspond liquid injection from the pump.

Example:

- a) Reference value set by user = 100 pulses.
- b) Maximum allowed variance = 12 pulses.
- c) Actual pulses detected by the pump = X pulses.

If  $100 - X > \text{or} = 12$ , then the pump will produce an audible alarm (buzzer). At the same time, the output relay will also be energized.

### **RELAY SERVICE OUTPUT**

Any time the pump is in alarm status generated by loss of injection sensed by the flow-sensor either from loss of power or from too many pulses in the mode 1xN(M) the service relay will be activated. Such condition will be present on the external connector and can be used. Such condition must be neutralized by touch the enter push-button with pump-working. Such condition is show on paragraph 7.0.

### **REMOTE CONTROL**

This function allows the user to activate or de-activate the pump from a maximum distance of 100 meters away, using a contact switch. Two different polarities are available.

### **BUZZER**

The pump is fitted with an acoustic alarm to warn the user (see paragraph 3.1, Flow Alarm). This sound alarm can be manually disabled if so desired.

### **CLOCK**

An on-screen clock is standard. This gives additional functions to the pump (eg. timer - see paragraph 3.5). The clock shows the following information:

- Time in hh:mm (hours:minutes) format
- Day
- Date
- Month
- Year

### **TIMER**

An in-built timer allows the user to program dosing cycles as follows:

- **Timer Disabled:** Pump works in manual mode without timer influence.
- **Daily Timer:** The user can program up to 8 start/stop cycles per day.
- **WEEKLY TIMER:** The user can program up to 8 start/stop cycles per week.

## **8.2 INPUT/OUTPUT EXTERNAL CONNECTIONS (FOR EXTERNAL ACCESSORY)**

As shows on paragraph 7.0 the four connectors are used for connecting the accessories.

Namely the accessories are:

- Level control switch;
- Flow sensor;
- Water meter output (Reed switch type);
- Signal 4-20 mA from any device.

One extra connector is used to sense the operation of the service relay (output relay).

It is very important to disconnect the power from the pump when connecting the accessories. It is also very important to protect the unutilized connectors with male connectors supplied with the pump.

Such operation will protect the internal circuitry from unwanted shorts and/or the power surge either from the operator or from different sources. There will be no accessible contacts after installation is completed. It is imperative that the accessories will be supplied by the factory to avoid unwanted mismatched situations and/or furthered possible damage (which in this case will be not covered by the warranty). Further more cables and accessories must be idoneous and rated for the proper voltage and type of insulation.

#### **SUMMARY OF TYPE OF CONNECTIONS**

**1. OUTPUT SERVICE RELAY:** such relay utilize the pins #1-2-3 (connector #1 paragraph 7.0) which are activated in case of alarm status.

It must be noted that the operation of such relay are as follows:

- when the power of the pump is not present the relay is relaxed: contact closed pin 1 and 3;
- when the pump is operational -no alarm condition- the relay is energized: contact closed pin 2 and 3;
- in case of alarm the relay is deenergized: contact closed pin 1 and 3; (such condition is the same of pump not powered).

**2. INPUT LEVEL SWITCH:** as shown on paragraph 7.0 the pins #3-4 from position 2 are dedicated to the operation of the level sensor. Such operation is activated by a float containing one magnet if the liquid is below the position or completely absent the float will slide down activating a reed switch.

**3. INPUT FLOW SENSOR:** as shown on paragraph 7.0 the pins #1-2 from position 2 are dedicated to the operation of the flow sensor .

**4. INPUT FROM WATER METER:** to clarify for operator our pump can be connected to a water meter generating reed switch signal proportional to a certain quantity of water passing through out. It must be clear that such signal are only of ohmic nature and they do not carrying any power. Connecting to the pump a different type of water meter generating any voltage will irrevocably damage the pump thus avoiding any warranty.

**5. INPUT mA SIGNAL:** as shown on paragraph 7.0 to the pins #1-2 from position 3 can be applied one signal 0-20 mA. Keeping in mind to connect the positive to pin #1.

**6. RS 232 e RESET:** the pins #1-2-3 of the connector #4 are dedicated to the updating of the internal software of pump. Further more the pins #3 and 4 can be shorted out, for one second, generating the RESET condition of the pump.

## **9.0 - TROUBLE-SHOOTING COMMON TO DLX - DLXB MF SERIES**

---

### **9.1 - MECHANICAL FAULTS**

As the system is quite robust there are no apparent mechanical problems. Occasionally there might be a loss of liquid from the nipple because the tube nut has loosened, or more simply the discharge tubing-has broken.

Very rarely there may be losses caused by the breakage of the membrane, or by the membrane seals in which case they have to be replaced by disassembling the four screws of the pump head fig. 10), when re-mounting the pump head ensure that the screws are replaced properly, along with "O" ring.

After repair, the metering pump will need to be cleaned of additive residues which can damage the pump casing.

#### **❶ - THE METERING PUMP GIVES PULSES BUT THE ADDITIVE IS NOT INJECTED**

- a. Dismount the suction and discharge valves, clean them and replace, see position (fig. 10). Should the valves be swollen, check valves material against our chemical resistance compatibility chart and fit correct valves. Standard valves are Viton. Upon request Silicon, EPDM (Dutral), Nitril and valves, ball check valve, K valve can be supplied.
- b. Check clogging of the filter.

**ATTENTION:** When removing the metering pump from the plant, be careful as there might be some residual additive in the discharge hose.

### **9.2 - ELECTRICAL FAULTS**

#### **❶ DISPLAY OFF, NO LED LIGHT ON**

- a. Check power supply line (AC plug, power cord, fuse and connections). If not working please contact the nearest distributor

#### **❷ DISPLAY ON, RED LED (POWER/STAND BY) ON, PUMP NOT OPERATIONAL**

- a. Check whole programming data previously inserted or push the Start/Stop button.

#### **❸ PUMP PULSES ARE NOT CONSTANT**

- a. Check that supply voltage is within +/- 10% of rated voltage

#### **❹ PUMP MEMORY NOT WORKING**

- a. Power up the pump for 12 hours at least to allow the internal battery to charge up (this is especially important during first start-up). If problem persist contact the nearest distributor.

#### **❺ FLOATING SWITCH (TANK LEVEL SENSOR) NOT WORKING**

- a. Check that the connection between level probe and pump is securely fastened.
- b. If problem persists make a short connection between pin #3 and pin #4 on the second connector at the pump body. In case the pump turns on the alarm, replace level probe. If problem persists, contact distributor.

#### **❻ PUMP NOT WORKING WHEN WATER METER MODES 1XN, 1XN(M) AND 1/N ARE SELECTED**

- a. Check that the connection between the water meter cable and pump is securely fastened.
- b. This function can be tested by selecting the 1 x N mode (choose a value of N), removing the water meter cable, then short-circuiting pins #3 and #4 on the pump connector for one second. If the pump pulses N times it is necessary to check the water meter. If problem persists, contact distributor.

#### **❼ PUMP ALARM NOT WORKING WHEN CONNECTED WITH FLOW-SENSING DEVICE**

- a. Check that the connection between the flow-sending device and pump is securely fastened.
- b. Ensure the pump is primed - the pump head should be filled with liquid.
- c. Start the pump again. If the alarm persist use a spring loaded on/off switch (the one with normally open contact) connect to #2 pump connector (pin #1 and #2) than follow instruction in section d.
- d. Select the manual mode on the menu screen. Set 30 pulses/minute; subsequently in the alarm menu set 4 reference pulses of and 1 the max difference therefore press start/stop: the pump will start working in manual way (turned on green led and flashing red led of the pulses). For every pump pulses press the on/off switch button to simulate the flow sensor: if the pump doesn't put itself in alarm, replace the flow sensor. In the case in which the pump goes in alarm simulating the flow sensor with the button to turn please contact distributor.



### **8 THE PUMP JUST SWITCHED ON GIVE TWO OR THREE INJECTION AND THEN STOP**

Check the Remote Control Menü and the Alarm Menü for proper setting. If setting are correct, reset the pump following the procedure described in chapter 9.3.

### **9 IN CASE THE ADDITIVE LEVEL IS BELOW THE LEVEL PROBE AND THE LEVEL ALARM IS STILL OFF**

Check the level switch connection, short circuit poles connector (Section 7.0 pos. 2), in case the alarm is on, replace the switch; if the alarm is off, contact manufacturer customer service, dealer or distributor.

### **9.3 RESTORATION OF DEFAULT PARAMETERS**

If for any reasons the user wants to erase all the parameters and re-start the pump to the default setting, press the START/STOP (9) button and contemporarily press PREVIOUS (8) and NEXT (2) arrows.

When START/STOP button is pressed the pump will reset to default setting.

This will cancel all set parameters.

# MAIN MENU

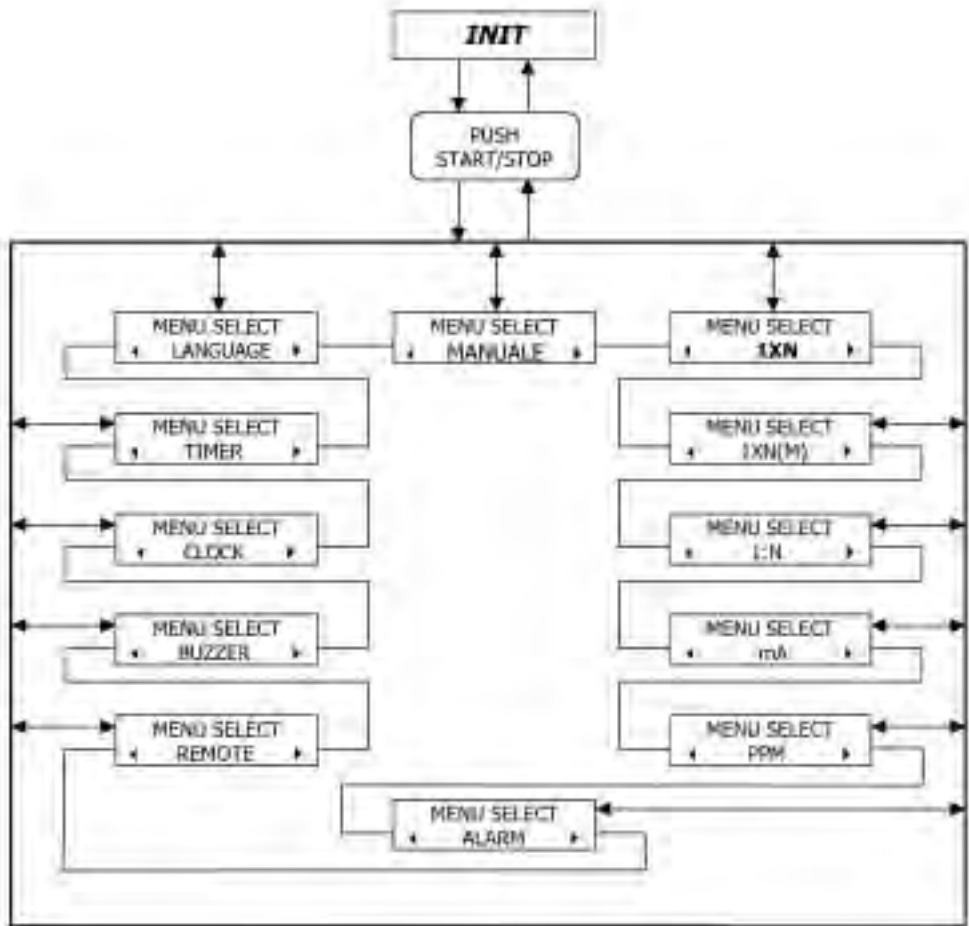

# MANUAL MENU

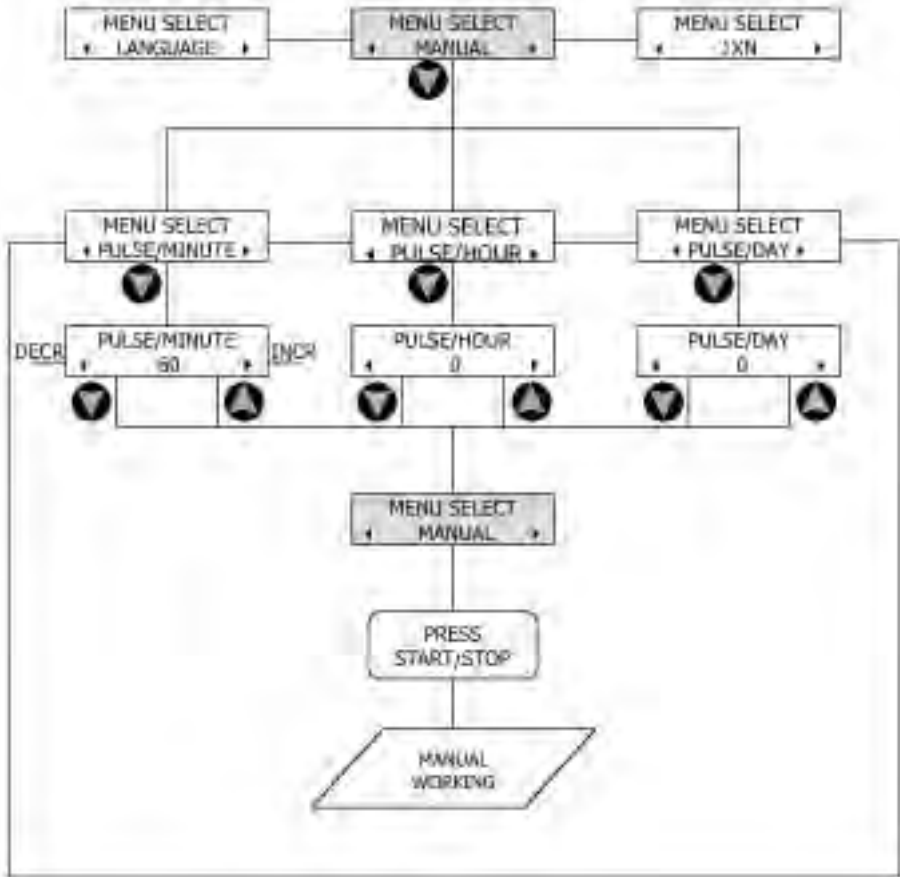

## 1xN MENÙ

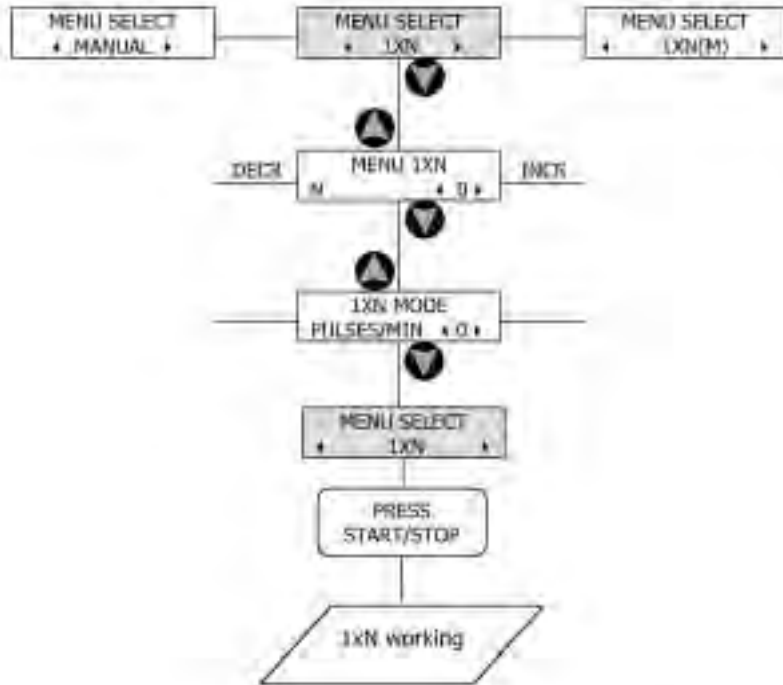

## 1xN (M) MENÙ

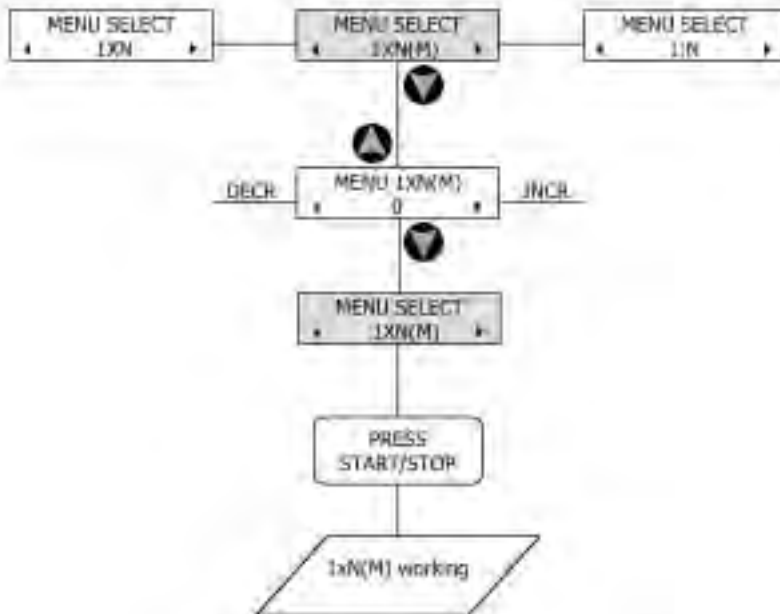

# 1:N MENÙ

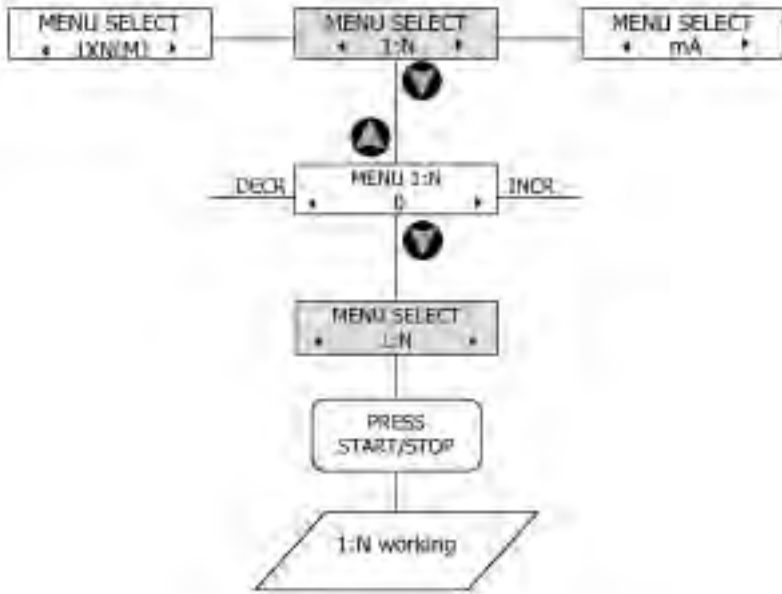

# mA MENU

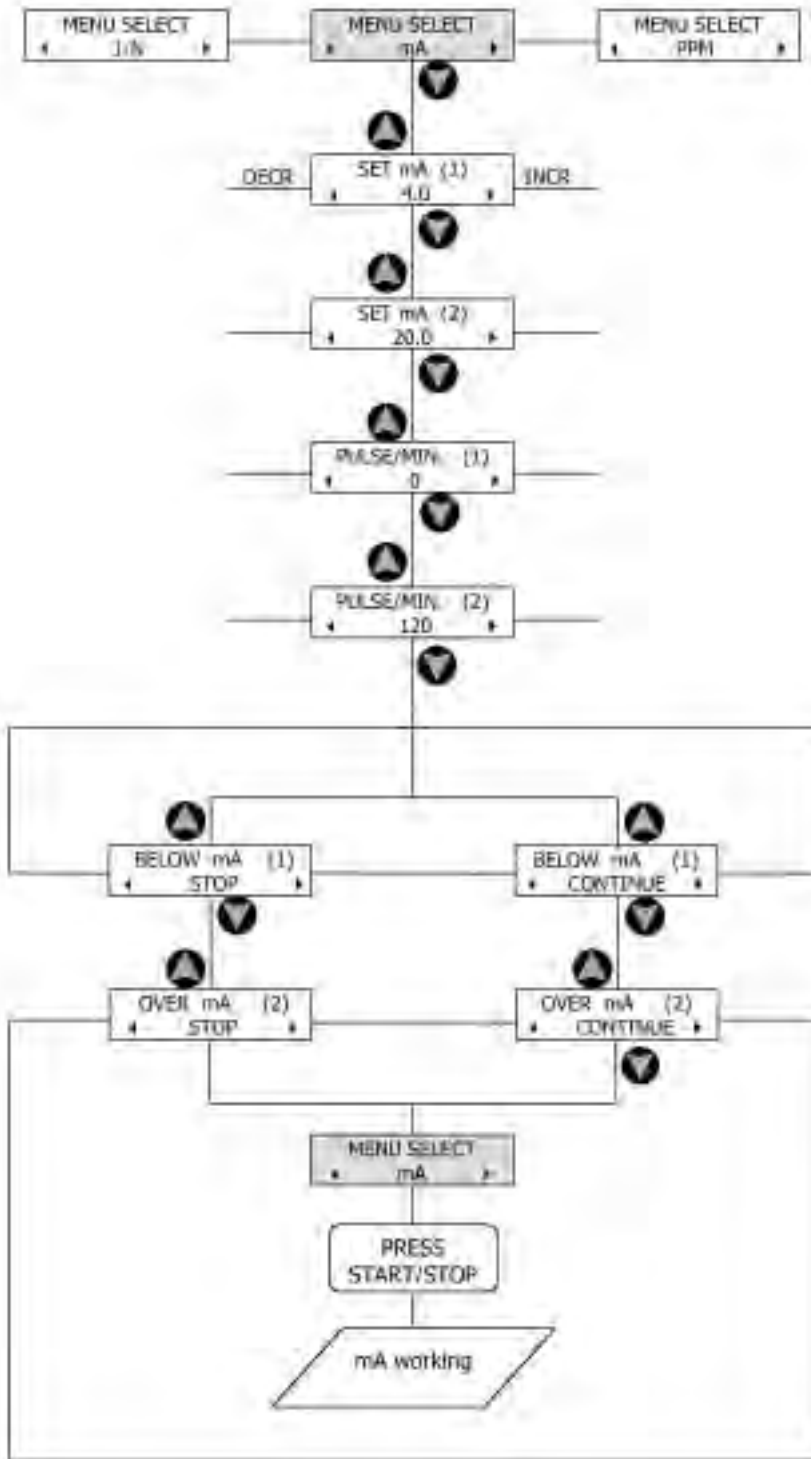

## P.P.M MENÙ

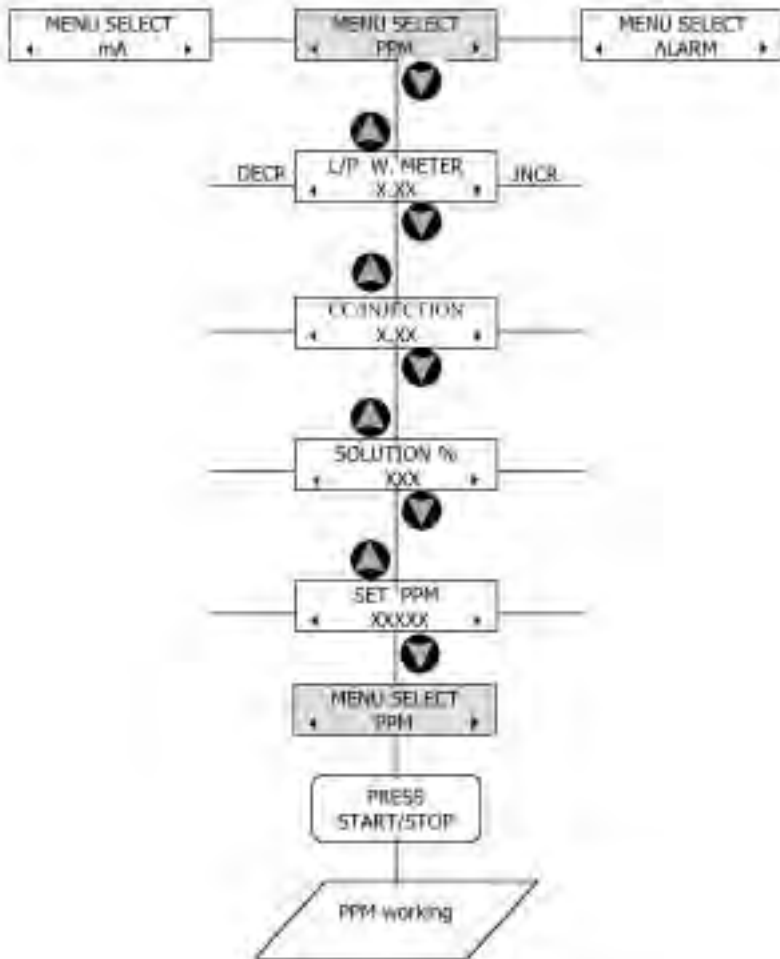

## ALARM MENÙ

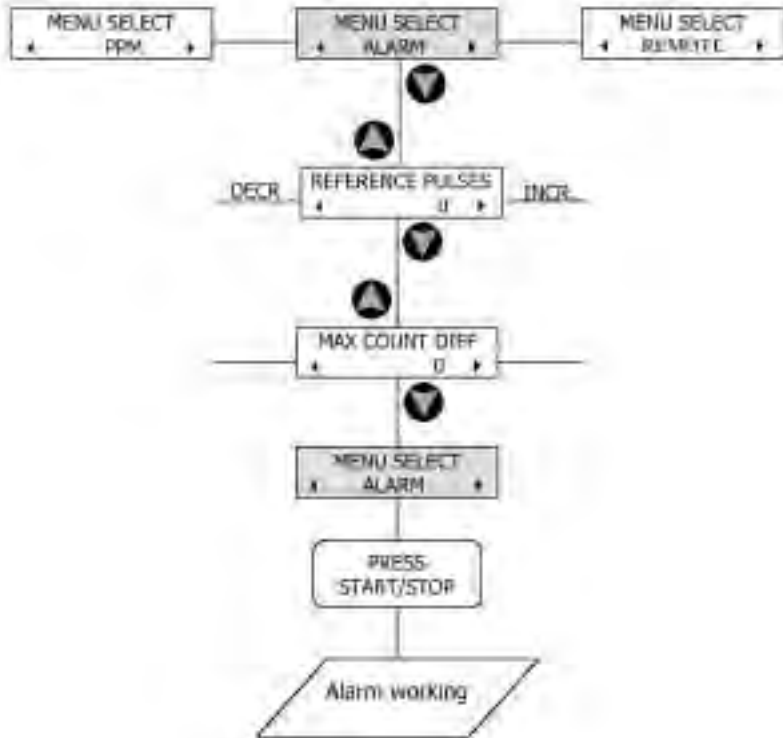

## REMOTE CONTROL MENÙ

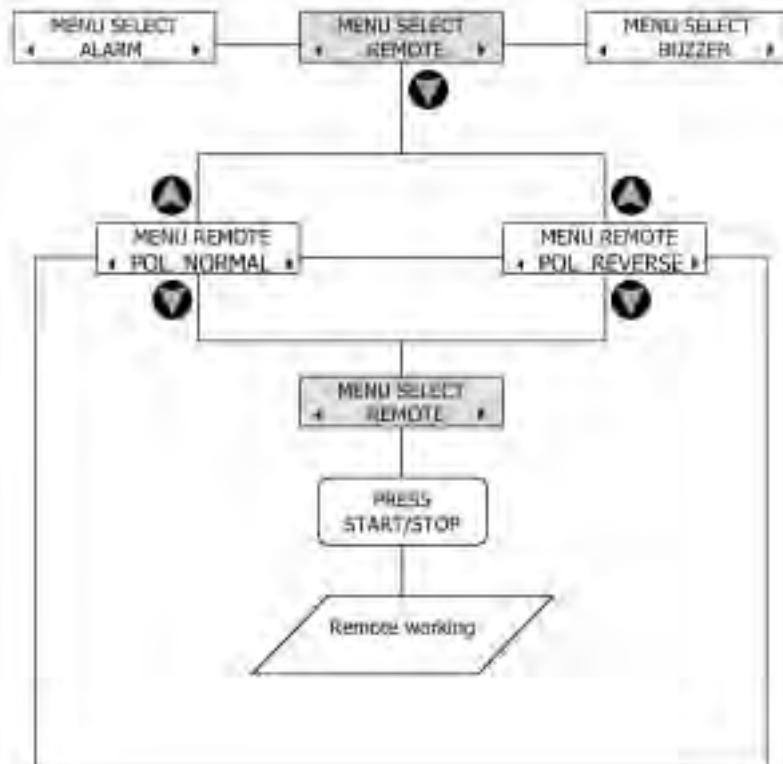



# BUZZER MENÙ

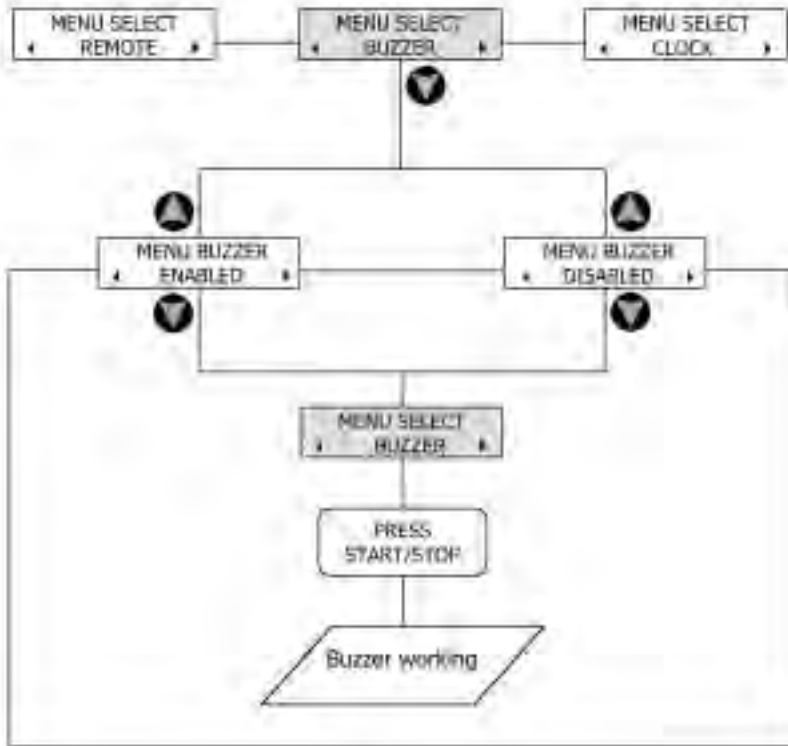

# CLOCK MENU

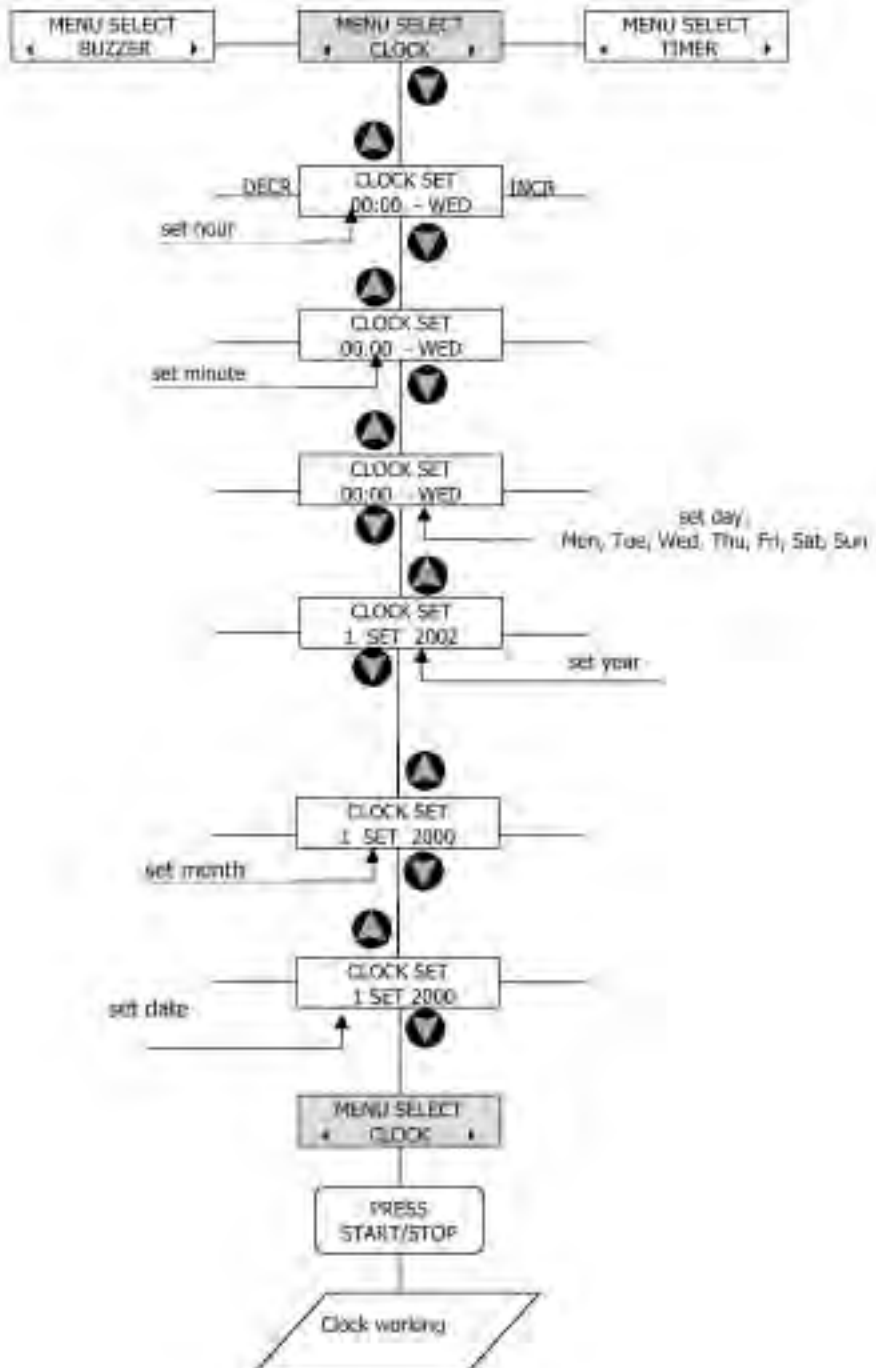

# TIMER MENU

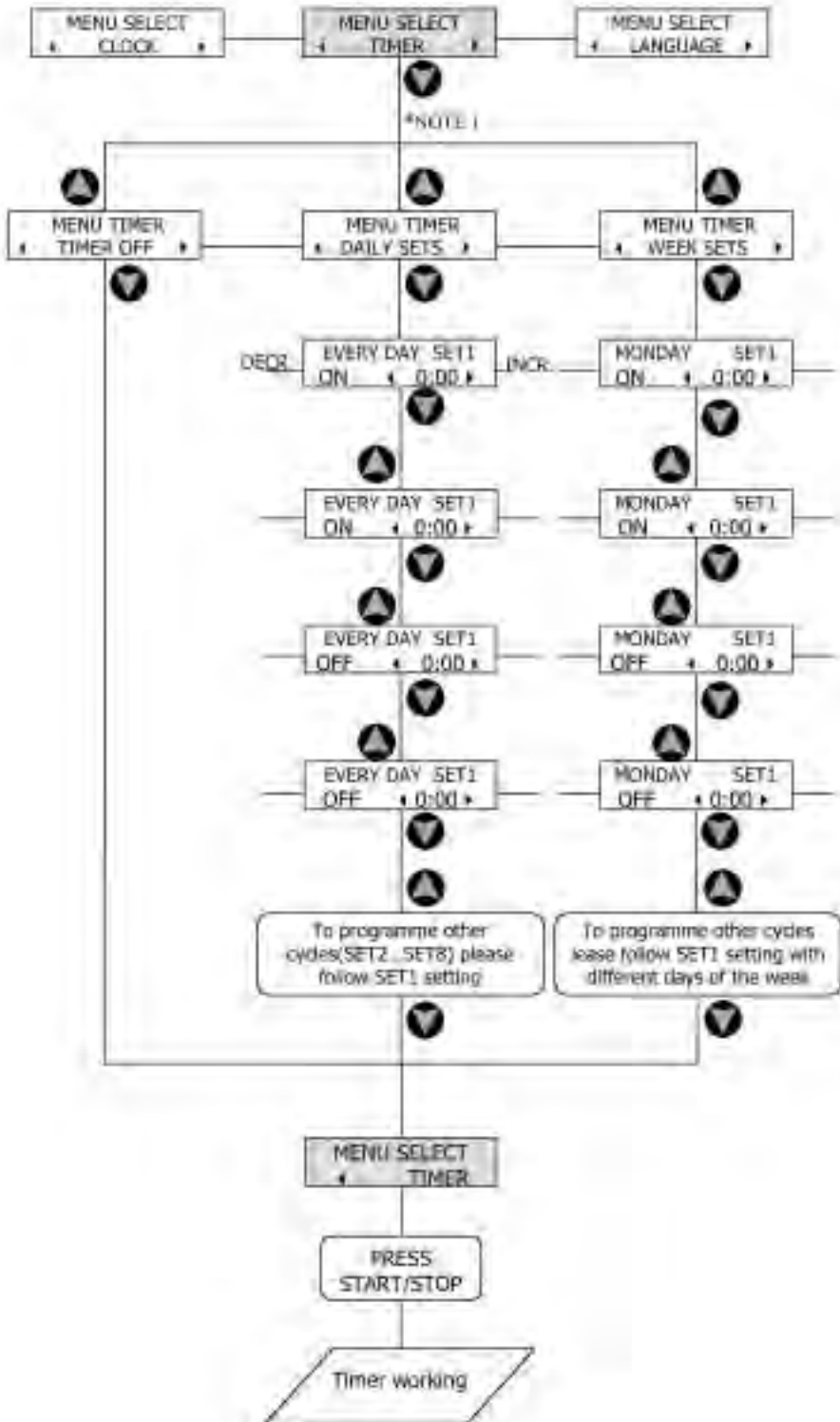

**NOTE 1:** After pressing **NEXT** button user can set the parameters of the last function which the access has happened. At the first switching on after having entered in **TIMER** sub menu, with the pressure of the **NEXT** button the recalled function will be **TIMER OFF**.

# LANGUAGE MENU

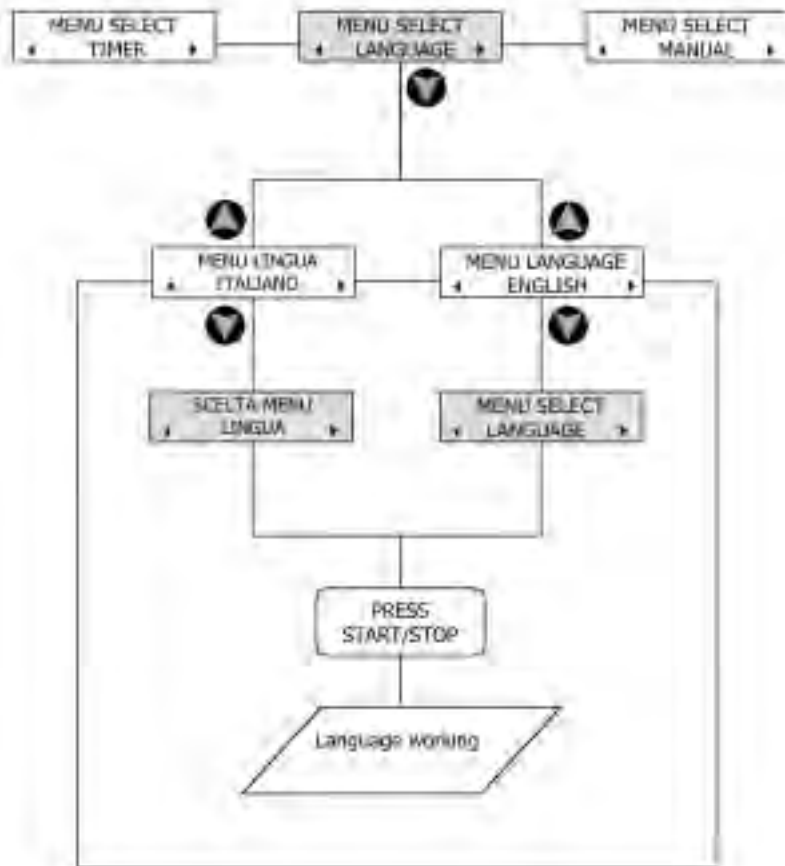



# ETATRON D.S.

HEAD OFFICE - ITALY

Via dei Ranuncoli, 53 - 00134 ROMA - ITALY

Phone +39 06 93 49 891 - Fax +39 06 93 43 924

e-mail: [info@etatronds.com](mailto:info@etatronds.com) - web: [www.etatronds.com](http://www.etatronds.com)

ITALY (BRANCH OFFICE)  
ETATRON D.S.  
Via Ghisalba, 13  
20021 Ospiate di Bollate  
(MI) ITALY  
Phone +39 02 35 04 588  
Fax +39 02 35 05 421

ASIA ETATRON D.S.  
(Asia-Pacific) PTE Ltd  
67 Ubi Crescent, #03-05  
Techniques Centre  
Singapore 408560  
Republic of Singapore  
Phone +65 67 43 79 59  
Fax +65 67 43 03 97

USA - CANADA - MEXICO  
ETATRON AMERICA  
1642 McGaw Avenue  
Irvine, CA 92614  
USA  
Phone +1 949 251 8700  
Fax +1 949 752 7867

ESPAÑA - ETATRON  
DOSIFICACION Y MEDICION S.L.  
Avda. Letxumboro 83  
Pabellón 6  
Irún (20305) ESPAÑA  
Phone +34 902 09 93 21  
Fax +34 943 09 03 12  
[www.etatron.es](http://www.etatron.es)

BRASIL  
ETATRON do Brasil  
Rua Vidal de Negreiros, 108  
Bairro Canindé - CEP 03033-050  
SÃO PAULO SP  
BRASIL  
Phone/Fax +55 11 3228 5774

RUSSIAN FEDERATION  
DOSING SYSTEMS  
3-rd Mytishenskaya, 16/2  
129626 Moscow  
RUSSIA  
Phone +7 495 787 1459  
Fax +7 495 787 1459

UKRAINE  
000 ETATRON - UKRAINE  
Soborna Street, 446  
Rivne, 33024 Rivne Region  
UKRAINE  
Phone +380 36 26 10 681  
Fax +380 36 26 22 033

UNITED KINGDOM  
Etatron GB  
Lindum Business Park  
Station Road North Hykeham  
Lincoln, LN6 3QX UK  
Phone +44 (0) 1522 85 23 97  
Fax +44 (0) 1522 50 03 77

ETATRON FRANCE  
1 Mail Gay Lussac  
95000 Neuville Sur Oise  
Tel: +33 (0)1 34 48 77 15  
Fax: +33 (0)1 78 76 73 95

A B C D

COD. ÖT WÄCCGHT ŠFÖZÁFFÖCÍ D